

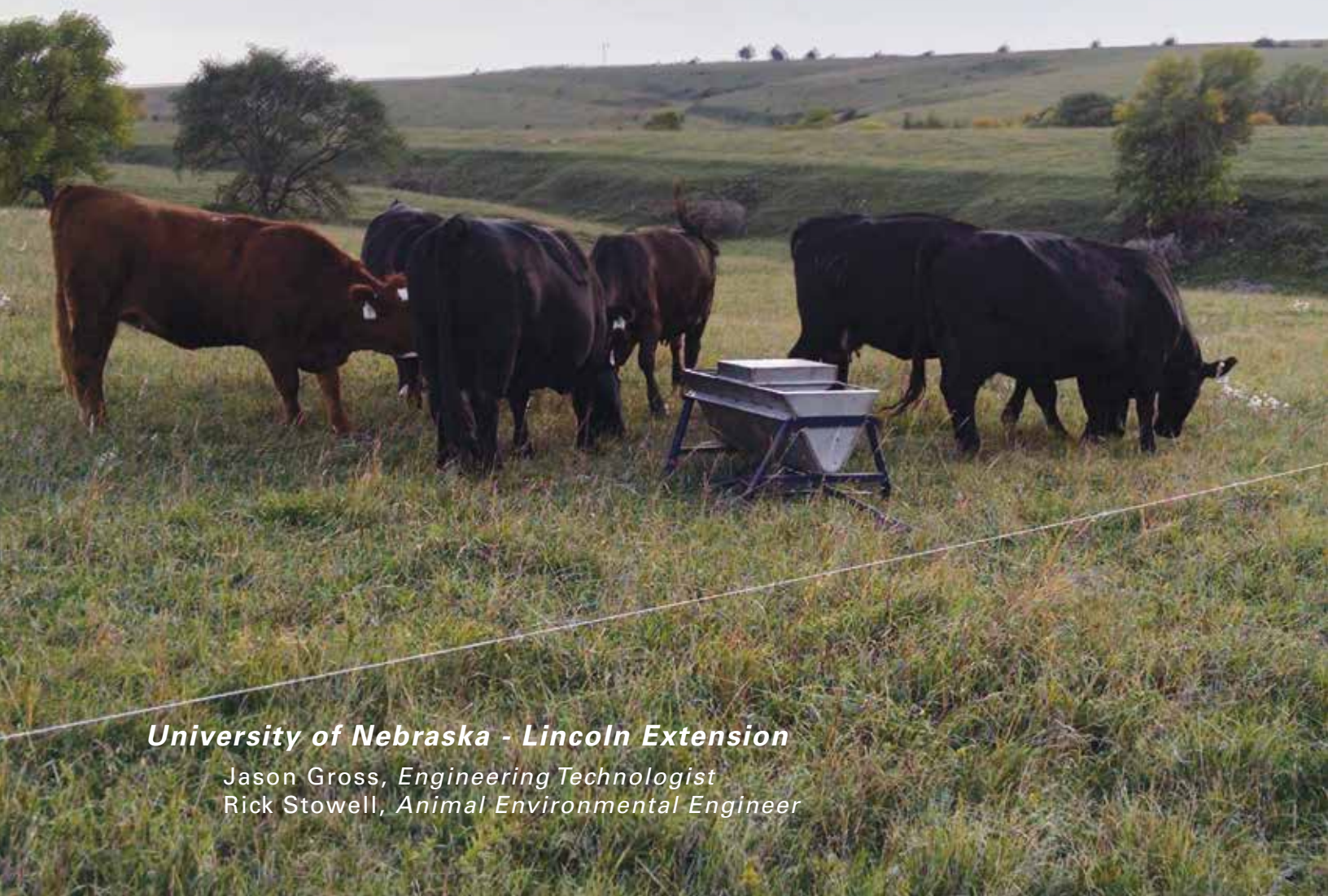

**EXTENSION**

EC3035

# **FENCE AND WATER DEVELOPMENT FOR EFFECTIVE GRAZING**



***University of Nebraska - Lincoln Extension***

*Jason Gross, Engineering Technologist*

*Rick Stowell, Animal Environmental Engineer*



Extension is a Division of the Institute of Agriculture and Natural Resources at the University of Nebraska–Lincoln cooperating with the Counties and the United States Department of Agriculture. University of Nebraska–Lincoln Extension educational programs abide with the nondiscrimination policies of the University of Nebraska–Lincoln and the United States Department of Agriculture.  
© 2018, Board of Regents of the University of Nebraska on behalf of Nebraska Extension. All rights reserved.

# FENCE AND WATER DEVELOPMENT FOR EFFECTIVE GRAZING

## TABLE OF CONTENTS

1. INTRODUCTION	<b>4</b>
2. ADDING LIVESTOCK TO AN EXISTING OPERATION	<b>5</b>
3. BASIC ELECTRIC FENCE DESIGN	<b>6</b>
- Barbed wire	
- Electric high-tensile wire fence	
- 3-wire permanent electric fence	
- Semi-permanent electric fence	
- Temporary and portable fencing	
4. BASIC WATER SUPPLY SYSTEM DESIGN	<b>15</b>
- Water system design basics	
- Flow and hydrant pressure measurement	
- How to Measure Flow and Pressure	
- Moving surface tubes and portable tanks	
5. IRRIGATED PASTURE DEVELOPMENT	<b>28</b>
- Center pivots	
- Towed systems	
6. PLANNING CONSIDERATIONS FOR GRAZING MULTIPLE CROPS	<b>33</b>
- Final summary	
7. REFERENCES	<b>37</b>

# 1. Introduction

There has been much interest in grazing alternative grasses and forages outside of native ranges. Grazing irrigated grass and annual forages, such as cover crops, can not only improve soil health and reduce soil erosion, but add grazing days to an existing operation. Grazing systems that include perennial grasses and cover crops, which were grown as a standard practice generations ago, have come back onto the farm. In order to graze grasses or cover crops on fields that have not been grazed in generations, there will have to be developments of fence and water system infrastructure in order to house and properly care for the livestock.

Basic grazing infrastructure for livestock includes fencing, water, and a method of controlling grazing activity. Without controlling how livestock will graze and harvest the forage, there will likely be incidences of soil compaction, overgrazing (removing too much forage), inconsistent residue height, and poor manure management. Grazing of pastures and seeded forages needs to be controlled so livestock efficiently harvest the forages and then the vegetated areas are provided proper rest and rehabilitation time for regrowth. This means having multiple paddocks or grazing cells, with easy access for moving animals from paddock to paddock. Turning a small group of cows into a big field of plentiful (e.g. 8,000 lb. per acre DM) forage would lead to only a small percentage of that forage being harvested. Most of the forage would be trampled and lodged into the soil and the cattle would not obtain a steady supply of quality forage – a large share of the plants would reach maturity before they are harvested.

In controlled grazing of grasses or annual forages, livestock harvest only the excess growth and do so with minimal loss of plant material. This forage removal can be justified by the placement of manure and the remaining plant residue that help build soil structure and provide nutrients for future crop growth, in combination with the weight gain of the cattle. It's important to keep in mind

that costs are always lower the more we allow the animals to do the work for us. By grazing more months, the costs of haying, feeding the hay, and the manure distribution are much less. Of the forage nutrients harvested by grazing livestock, 60-95% will be returned to the field in manure and urine (Wilkinson and Lowrey, 1973). Grazing of grasses or annual forages for optimal crop and animal performance doesn't just happen by chance, it requires implementation of an appropriate grazing strategy (using multiple cells or paddocks) and the necessary infrastructure to manage and maintain livestock.

Developments in fencing and water systems have greatly improved capabilities to manage cattle and forage for controlled grazing. New technologies in electric fencing have made it easier to build and maintain fence. Most importantly, modern fencing has become more reliable. Placing permanent water tanks and buried pipelines in crop fields can be expensive. Permanent tanks inevitably lead to mud from persistent animal traffic or an enlarged footprint being dedicated to a concrete, gravel or otherwise improved pad. These features reduce the productive capacity of the field and create obstacles for farm equipment. Portable tanks and surface tubing can help to greatly reduce construction costs. Multi-cell grazing can be implemented in current crop fields during frost-free months with only a minimal amount of buried pipeline and frost-protected tanks or hydrants. Portable tanks and surface tubing can take care of the rest.

This publication provides guidance to producers in the development of grazing strategies in crop fields or existing pastures that have minimal or no existing infrastructure. Also it shows some examples of including grazing forages in crop fields as part of a larger system that may include grazing native ranges and irrigated pastures, and the use of confined feeding.

## 2. Adding Livestock to an Existing Operation

A majority of cattle operations in the Great Plains use pasture or native ranges for grazing during the growing season and crop residues or harvested/purchased feed for the remainder of the year. In order to expand cow or calf numbers, typically more land will have to be purchased or rented. If land is available, it will be acquired or become accessible at some expense. Trends in Nebraska and surrounding states continue to show a decline in available pasture land and rangeland. Meanwhile, there is high demand for land to raise row crops and for other uses. The resulting price pressure on land values leads livestock producers to consider alternatives for expanding animal numbers without expanding their land base. Alternatives may include grazing cover crops in the production of traditional commodity crops, irrigation of grazed forages, and introduction of grasses (perennials) into existing crop rotations (Figure 1).

For a cow to produce and sustain a calf or for a calf to grow, it must consume enough dry matter

to maintain itself and support that production. As ruminants, cows and calves are excellent harvesters of forage – with the ability to convert forage into gain. The goal of any grazing operation is to introduce the cow or calf to forage in adequate quality and quantity for their needs. Producers can provide this forage with native ranges, irrigated or introduced pastures, or annual forages. Grazing operations that utilize their native ranges and introduced forages in crop acres can extend the grazing season. It is not unheard of for a grazing operation to reach 12 months of grazing in the Great Plains. Cattle are supplemented when needed and an emergency hay supply is fed only when there is extreme weather. Expanding the grazing season reduces machinery and personnel time needed to put up and feed hay. For start-up operations having limited capital, such a strategy may be one of the few ways for a young family to start farming and ranching.



**Figure 1. Cattle Grazing Annual Forages. Image courtesy of USDA - MARC.**

# 3. Basic Electric Fence Design

Fencing and water systems have been controversial subjects since Joseph F. Glidden invented the prototype of modern barbed wire in 1874, allowing landowners to keep ‘free grazers’ away from their range and water sources. To stop the resulting range wars, states created fencing boundary laws, which have undergone frequent changes through today. As we take a closer look into fencing as something more than just a boundary marker, we find a management tool for improved cow and calf performance, range/ forage production and quality, and soil health. Fence product manufacturers have not been stagnant in the development of new and improved products. As livestock producers look into different grazing strategies and expanding into grazing crop fields, it is time to take a new look at the fence and water system products that are now available.

Fencing serves several functions. It can be a property boundary marker, a physical and/or psychological barrier for animals and people, and a tool for managing livestock grazing behavior. Internal cross fences, whether they are portable or permanent, function to work with the grazing behavior of livestock to achieve a desired result – they allocate cattle a prescribed amount of grazing area (referred to as a paddock or cell) within the larger range or field. The fencing scheme selected also largely determines labor input. A continuous, whole-field grazing operation will have the least amount of fence and labor input while an intensely managed, multi-cell system can have quite a bit of

fencing and labor inputs. There are many options in fence type and construction, so it is preferable to first investigate and choose a management practice; then the fencing can be selected to match the needs of the chosen management plan.

The following is a brief look at some of the more popular types of fence and construction methods. Currently cattlemen are looking for new grazing opportunities and want to expand grazing onto forages in crop fields, so adapting fence and water systems to these applications is highlighted.

## Barbed wire

Invented in 1874, barbed wire has been a standard fence ever since. Barbed-wire fence uses 12.5-gauge barbed galvanized steel wire with creosote posts that are 3.5 or 4 inches in diameter and 6.5 feet long. Typical barbed-wire fence is constructed with 4 to 6 wires. Using material cost at current retail prices from a farm store in Central Nebraska, a 4-wire barbed-wire fence costs near \$1.00 per foot (2017).

Barbed wire has many advantages. It is a visual and physical barrier for livestock and humans. Barbed-wire fence involves fairly simple construction methods and has proven its effectiveness over time. When quality materials are used, barbed-wire fence can last many years. Most barbed-wire fence uses simple box-corner construction (Figure 2) and intermediate post spacing at 16.5 feet (1 rod).

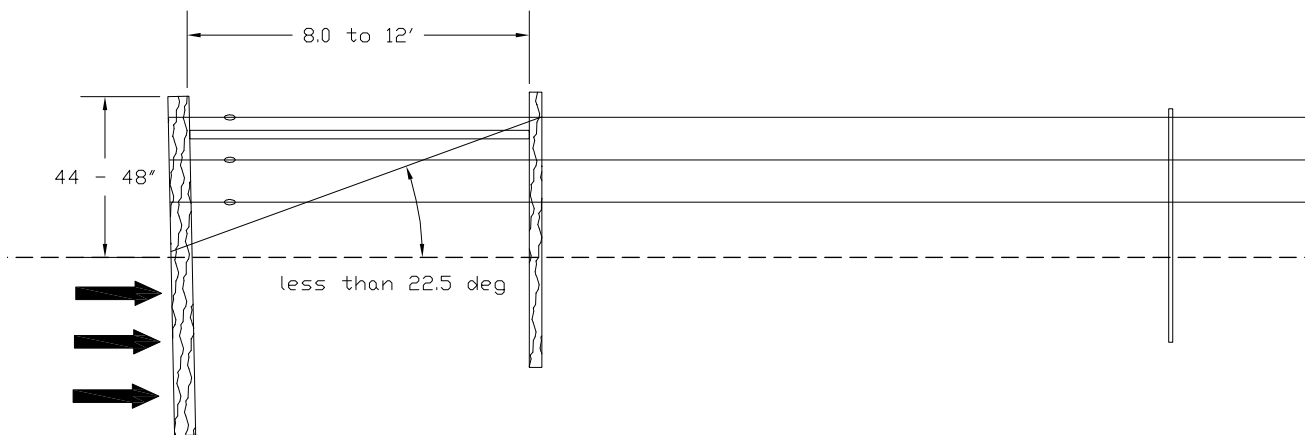

**Figure 2. Simple box-corner construction used with barbed-wire or permanent electric fence.**

When building these corner systems it is important to use at least a 5" x 8' corner post, 4" x 6.5' brace post, and a horizontal brace with a length of 8 to 12 feet. When the horizontal brace length is 8 feet or longer the bracing wire angle is lower than 22.5 degrees. This low angle transfers tension forces in the wires away from the top portion of a corner post to lower sections of the post. The net effect is similar to applying the redirected force as soil compression forces in the lower half of the corner post (see arrows in figure), working to keep the post upright. Box corners that have horizontal braces of 6 feet between posts will have brace wire angles of nearly 30 degrees, resulting in noticeably larger rotational force being applied to the corner posts. Excessive wire tension and inadequate box corner construction will tend to tip corner posts inward, making it very difficult to keep wires tight.

There are some disadvantages to barbed-wire fence. As the fence ages, maintenance will be an issue. Creosote posts at rod spacing give the producer many posts to check and to replace as they deteriorate. Wildlife may find it difficult to pass through 5- and 6-wire fences and resulting struggles can damage the fence. Barbed wire also is susceptible to dynamic loads from snow, ice, and

livestock pressure. The more wires the greater the loads. In order to resist these loads, double corner posts may be necessary.

#### Electric high-tensile wire fence

Permanent or semi-permanent electric perimeter fences along with portable electric cross fencing will be the best option for cattlemen looking to adopt intensively managed grazing practices or expand grazing into crop fields. Electric fence is more of a psychological barrier than a physical one. Since the wire is suspended using tension springs and inline strainers, fewer intermediate posts are needed. Coated fiberglass posts have a lower cost and longer lifespan than creosote posts.

Over the past several years manufacturers have offered more options and more reliable components for electric energizers. These energizers come in a wide arrangement of output power and power supply options. They can operate from 120-volt or 12-volt batteries with solar recharging systems and some are remote controlled. Solar energizers that use the newest technology in solar panels and voltage regulators/controllers can provide many years of reliable service. Some of the new controllers will identify the battery charge, self-diagnose for

problems, and equalize a flooded battery for longer life. Always follow manufacturer recommendations for energizer size and use.

The most challenging component of any electric fence is proper grounding. A rule of thumb is to use one 8-foot ground rod per 5 joules of energizer output or a minimum of three 8-foot ground rods spaced at least 10 feet apart. The fence ground has to be independent of other electrical grounds and the fence should not run parallel or be within 50 feet of buried telephone lines. Only use galvanized ground rods for steel wire. Copper rods can cause electrolysis in the energizer. Electrolysis can happen in electrical currents when dissimilar metals are used and can result in corrosion on electrical connections.

In order for the electric fence to be effective as a barrier, the electric circuit has to close when a cow or calf touches a 'hot wire', allowing the electrical current to pass through the animal to 'ground'. This will give the animal the intended 'snap'. Closing the circuit can happen through an earth return or a ground-wire return. From a design perspective, the decisions that need to be made relate to the number of wires needed and whether one or more wires need to be ground wires.

In an earth return, current travels through the soil on its way to a ground rod (Figure 3). When an animal touches a hot wire (+) the current passes through the animal and into the soil, the current will then travel through the soil to the nearest ground rod and back to the energizer to close the circuit. Single-wire fence and fencing having only hot wires are completely dependent on an earth return, which may work well for short fence runs in areas where the soil seldom gets dry. Under normal operation, voltage in the hot wires should be above 3,500 volts. Dry soils have much higher electrical resistance than moist soils. The voltage loss can be so great that the animal may experience a weak to no snap. In regions where soils typically become dry, electrical fencing needs to have at least two wires with one wire being grounded. The 'ground wire' should be grounded at the energizer and in multiple locations along the fence. One ground rod per quarter mile of fence may be necessary. This provides the current a shorter route to a ground rod when the livestock are far away from the energizer. Where feasible, place ground rods in areas where the soils are normally wetter, such as in the bottom of a canyon or in a wetland, to improve reliability that good earth return occurs.

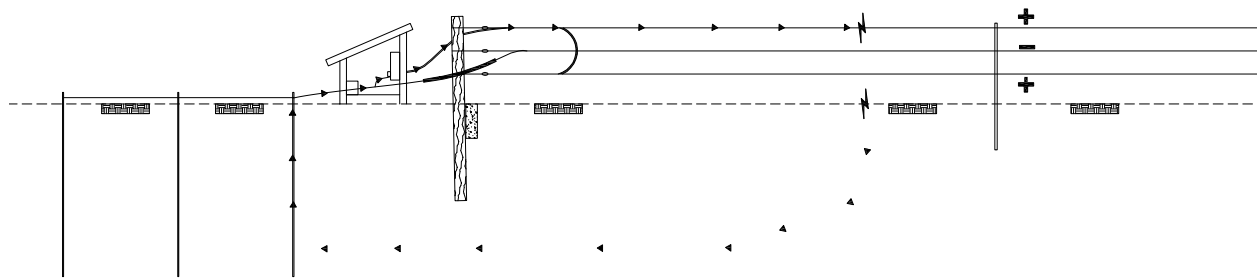
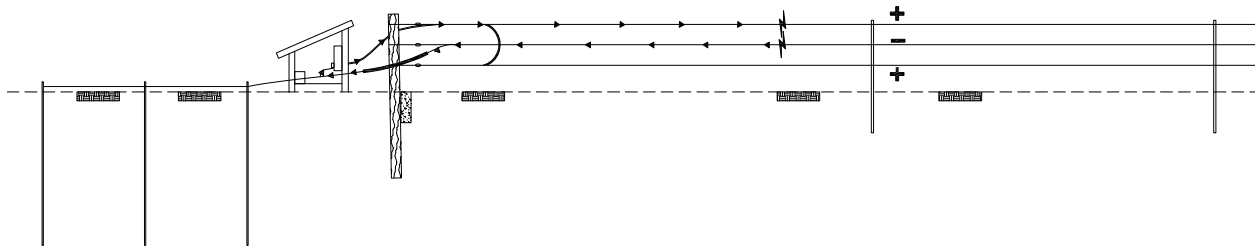

**Figure 3: Electrical circuit with an earth return. In this case, a cow or calf (not shown) touches a hot (top) wire and the current flows through the animal into the earth.**

In a fence with one or more dedicated ground wires, the electrical circuit may be closed by a ground-wire return (Figure 4). This occurs when the cow or calf touches a hot wire (+) and a ground wire (-) at the same time. This closes the circuit with the least amount of resistance, resulting in a reliable snap.

Use of fencing with ground wire that is properly grounded at the energizer and at multiple locations along the fence helps to ensure that electric fence performs reliably. All permanent electric fences in arid or semi-arid regions should have at least 1 ground wire.





**Figure 4: Electrical circuit with a ground-wire return. In this case, a cow or calf (not shown) touches a hot (top) wire and the ground wire below it at the same time.**

### 3-wire permanent electric fence

The most common permanent electric fence uses three wires, where two wires are hot and one is the ground wire (Figure 5). Generally the middle wire is ground, but the arrangement can be changed if all the wires are insulated. This fencing uses 12.5-gauge high-tensile wire (140,000 psi minimum), tension springs, 7/8" x 60- or 66-inch coated fiberglass posts (pre-drilled), 6" x 8' corner posts, and 4" x 7' line posts. Fiberglass post spacing can range from 25 feet to 80 feet. Post spacing is dependent on the terrain. Rougher topography tends to require closer post spacing. The coated fiberglass is smooth and easy to pull out of the ground. Areas in the fence where the wire applies an upward force on a fiberglass post must be supported by a 'dead man' or the post must be replaced with a wooden line post. Placement of a wooden line post at least every 300 feet in open and flat areas helps stabilize the fiberglass posts from dynamic loads caused by snow, debris (e.g. tumble weeds) and wind.

A great advantage of the 3-wire fence is that the top wire is 38 or 40 inches off the ground and the bottom wire height is 16-18 inches. This is adequate to hold in livestock, but allows antelope to pass under the bottom wire and deer and elk to pass over the top wire without much impact to the fence. Also the 18-inch bottom wire height allows room for a working dog to pass underneath.

One key feature of a 3-wire electric fence is its ease of construction. Fencing contractors that have skid loaders and wire trailers with multiple wire-spinning 'Jennys' can build this fence rapidly, which is usually a good value for the producer. A skid loader with a powered auger (post-hole digger) or post pounder is invaluable to fence construction. Also, the loader's bucket can be used to push in fiberglass post. A post height gauge can be made out of a 44" steel pipe. This helps set a consistent post height and also minimizes shattering of posts as they are pushed into the ground.

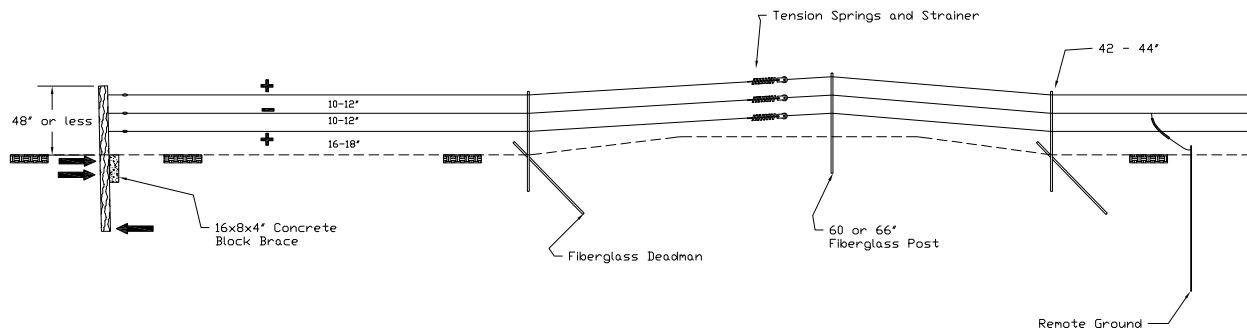

**Figure 5: Three-wire fence with a block-braced corner post.**

One important feature that can be used in electric fences having up to three wires is block bracing (Figure 5). The forces applied to a block-braced corner in a 3-wire fence are normally not enough to tip the corner post. A 16" x 8" x 4" solid concrete block is placed crosswise tightly between the post and the soil on the side where the wires attach to the post. As tension in the wires pulls on the post, the block gives a larger soil surface area to resist the over-turning forces (see arrows). Fences with 4 or more wires should use the stronger simple box corner construction (Figure 2).

Beyond being effective fencing, one of the main advantages of a well-constructed permanent electric fence is that it serves as a primary conductor of electricity and provides a ground wire to different areas of the pasture system. Wherever permanent electric fence is located, there is opportunity to electrify another fence into it with temporary or portable fencing. Figure 6 shows a portable cross fence attached to an existing 3-wire permanent fence with a gate.

When using a skid loader with a powered auger to build this fence, use the 12-inch auger bit for the corners and the 6-inch bit for the line posts. Set the corner post where over 50% of its length is buried. If the top wire height is 38 inches, then set the corner at 44 - 48 inches in height. Place the block in the bore hole so that as the post is being pulled by the wire it pushes into the block. Tamp well around the block and the back of the post.

Table 1 provides a materials list for 3-wire electric fence along with retail prices from a farm store in Central Nebraska in the summer of 2017. The cost per lineal foot (36¢/ft.) for a ½-mile fence is less than half that for barbed-wire fence; however, this cost does not include a gate or the energizer. A skilled crew of two fence builders with a skid loader and ATV can build this fence in half a day. This price excludes the cost and time to build a gate in the fence.



**Figure 6. Three-wire fence with gate and connection of portable cross fence. Photo credit Jason Gross.**

**Table 1. Materials and price list for a 1/2-mile stretch of 3-wire high-tensile fence [without an energizer or gate]. 2017 Prices from a farm store in Central Nebraska.**

Part	Price \$	# in package	Price \$ (ea)	# Needed	Total price \$
6" x 8' treated post	13.99	1	13.99	2	27.98
4" x 6.5' treated post	5.99	1	5.99	7	41.93
7/8" x 66" FG post	7.89	1	7.89	60	473.40
Concrete block	1.44	1	1.44	2	2.88
Wire roll	109.99	4,000	0.03	8,000	219.98
Cotter keys	5.90	50	0.12	200	23.60
Crimping sleeves	5.29	25	0.21	25	5.29
Post insulators	7.49	25	0.30	14	4.19
End strainers	7.79	10	0.78	4	3.12
Strainers	4.99	1	4.99	6	29.94
Tension springs	8.49	1	8.49	6	50.94
Ground rods	18.99	1	18.99	3	56.97
Insulated wire	18.99	50	0.38	20	7.60
				Total	\$947.82
				Total per ft.	\$0.36

### Semi-permanent electric fence

There are often installations that are suited for a class of electric fence that may not be permanent, but is not portable or temporary fence either. This 'semi-permanent' fence looks similar to permanent electric fencing, but it uses different wire and posts. Semi-permanent fence can be placed relatively quickly and, with a little work, can be removed. Fencing like this may make a perfect cross fence for rented property, where the landowner is not interested in building fence infrastructure. The fence can remain personal property of the tenant and be removed when the lease is over. This fence also can be constructed as perimeter fence or cross fence in crop fields. It is stronger than single-wire temporary fence and stands up better to wildlife. Semi-permanent and permanent electric fence can both work to convey electric power and ground wire to the center of a pasture or paddock. The producer can tie off on this fence at any place to attach poly-wire cross fencing. This can help minimize

the length of poly-wire fence and provide a low-resistance conductor and ground wire from the energizer to the center of a pasture or paddock.

Semi-permanent fence is constructed using block bracing on the corners, but the corner post can be 4" x 7' posts. Wood line posts can be 3 to 4 inches in diameter. Fiberglass posts can either be 7/8" x 60" or the lower-cost 11/16" x 54" posts. Use 14-gauge galvanized steel wire with strainers and tension springs. This wire is not as strong as high-tensile wire, but it is easy to work with when repairing. Generally, semi-permanent fence is constructed with two wires, with the top wire being hot and the bottom wire ground. Build the fence with both wires insulated so the polarity can be reversed to make the bottom wire hot or both wires hot. This is helpful to teach young calves about electric fence. At about 24¢ a foot, semi-permanent fence saves about a third of the materials cost of permanent electric fence (Table 2).



**Figure 7. Temporary fences constructed using 14-gauge wire and rebar posts are often used to hold cattle while grazing corn fields after harvest. Photo credit Jason Gross.**

**Table 2. Materials and price list for a ½-mile stretch of semi-permanent fence [2-wire, 14-gauge galvanized steel without an energizer or gate]. 2017 prices from a farm store in Central Nebraska.**

Part	Price \$	# in package	Price \$ (ea)	# needed	Total price \$
4"x6.5" treated post	5.99	1	5.99	9	53.91
11/16" x 54" FG post	5.75	1	5.75	60	345.00
Concrete block	1.44	1	1.44	2	2.88
Wire roll (ft)	43.99	2,640	0.02	5,500	91.65
Cotter keys	5.90	50	0.12	120	14.16
Post insulators	7.49	25	0.30	14	4.19
End strainers	7.79	10	0.78	4	3.12
Strainers	4.79	1	4.79	4	19.16
Tension springs	8.49	1	8.49	4	33.96
Ground rods	18.99	1	18.99	3	56.97
Insulated wire (ft)	18.99	50	0.38	20	7.60
				Total	\$632.59
				Total per ft.	\$0.24

### Temporary and portable fencing

Perimeter fences will generally follow the property or field boundaries, but cross fence can be built many different ways. When laying out permanent cross fence and water systems it is necessary to have a full understanding of what temporary or portable fence will be used and how. In Nebraska, for example, cattlemen prefer to construct temporary fences using 14-gauge or smaller galvanized wire with 48-inch rebar line posts and t-posts or wood posts at corners. This sort of temporary fencing is used extensively in grazing crop residues in the fall and winter. The fences are installed after the crop is harvested and are used throughout the grazing period (Figure 7).

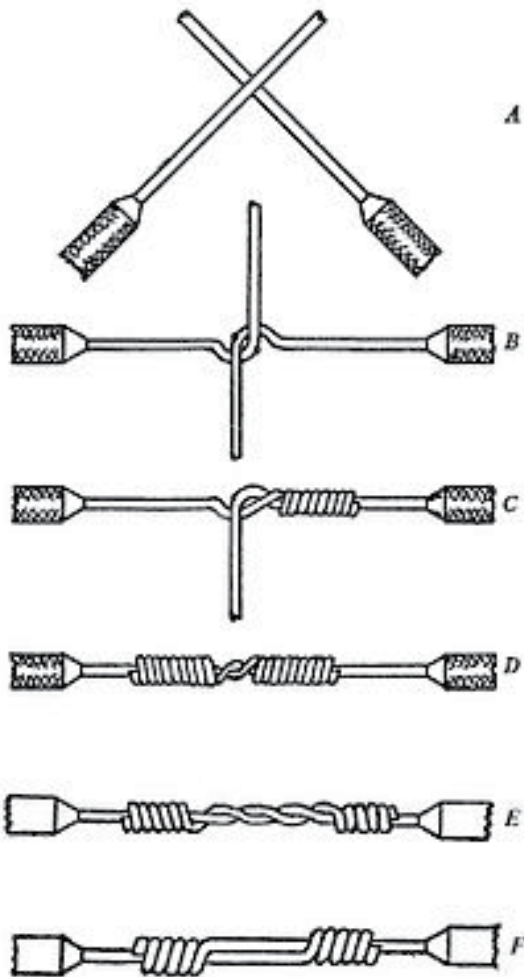

**Figure 8. How to tie a Western Union splice (A-D) and splice appearance under tension (E-F).**

Advantages of this temporary fencing are that it is simple and easy to install, relatively low cost at less than \$0.20/ft., and it is moveable and reusable. Temporary fence is generally built with just one wire with ground rods at the energizer, but in areas having dry soils a second wire can easily be added as a grounding wire to make the fence more effective and reliable. The galvanized steel wire is easy to roll up and reuse. The 14-gauge wire is also easy to repair and splice together. Like all electric fence, the splice needs to be set tight so there is no loss of continuity. A Western Union splice (Figure 8) is easy to form and is generally considered the best splice for electric fence.

While temporary fencing offers convenience and low cost, it also has many disadvantages. The threaded insulators and steel posts are susceptible to damage from wildlife. The single wire is difficult to see; deer and elk are prone to run into newly installed wire and pull off the insulators. A well-grounded fence with an adequate energizer will, in time, train the local wildlife to avoid or jump over the wire, but this may take a few weeks. The posts are difficult to install in frozen soils and also almost impossible to pull out of frozen soils without bending the post. Despite these limitations, temporary fence can be an asset as part of a whole grazing program using other fencing options for defining perimeters and other roles.

A portable fence serves a completely different role. These fences are generally used in one position for a short time, from a week or so down to a few hours at a time. Portable fencing is by far the easiest to pick up and move. The fence consists of a step-in post, poly-based wire or tape, and a hand reel to roll up the poly wire.

The posts and hand reel are lightweight and easy to carry in your hand or on an ATV (Figure 9). Many producers who use poly wire and step-in posts customize their ATV with mounts to store posts, and spool out and roll up poly wire. As the ATV is driven in the path of the new fence the reel spools out poly wire and the posts can be installed on the go. With a little practice, a person can pick up 1,000 feet of fence in under 20 minutes and can reinstall it in about the same amount of time.



**Figure 9. Assortment of portable fence posts and a hand reel with wire braid.**  
**Photo credit Jason Gross.**

As the name implies, the major advantage of portable fence is its ability to be moved quickly. The poly wire is a fabric-based rope (about the size of baler twine) with stainless steel wire woven into it. Keep in mind that the more wire braids in the fabric (6 to 9 wires or more), the better the conductivity of the poly wire. Also, with prolonged use, some of the small wires can break and lose continuity. The more wires in the poly fabric the better it is for minimizing voltage loss and extending fence life. Poly-based fabric comes in different thicknesses of braided rope and poly tape. The thicker braided rope and tape are stronger and also easier for livestock and wildlife to see. The main disadvantages of braided rope and tape are that they are heavy and their bulk makes a reel hold less feet of fence than the thinner poly wire

Positioning of permanent cross fence in a pasture or a crop field to maintain acceptable portable fence length is a major consideration in the planning of permanent fence. Portable fencing should be less than 1,300 feet long and preferably under 1,000

feet. Cross fence can be designed so the length of a move can be predetermined. In addition to designing portable fence to improve forage production and grazing, fence layout should also account for the time available for moving the fence. Match the total length of fence to be regularly moved to the time available for moving fence. If time for this chore is minimal, then design the cross fence to use relatively short fence runs. Each system can be designed to fit a particular management system.

Reels come in different sizes and may or may not have geared crank mechanisms. Standard reels hold about 1,300 feet of poly wire. Larger reels hold more wire, but the reels can get very heavy. For most people, it may be too heavy to hold with one hand. Practice with various sets of hardware to find what works best for you. The best option is what works for you and your situations. There are no standards for portable fence, only what works and gets the job done. Fortunately, portable fencing equipment is relatively low cost, so experimenting with different products until you are satisfied is usually worthwhile.

## 4. Basic Water Supply System Design

Cattlemen are increasingly adopting rotational grazing approaches that involve smaller paddocks with more frequent movement of cattle from one paddock to the next. Supplying water to multiple paddocks can be a significant challenge in rotational grazing systems. When looking to graze cattle in crop fields, cattlemen will need to figure out how to reliably supply water without using permanent tanks. For many landowners, concerns over the cost of installing permanent tanks, compaction around the tanks, and general inconvenience of having permanent tanks in crop fields have deterred them from grazing these fields. One promising solution is to use portable stock tanks with moveable surface tubing (Figure 10).

Buried water lines and mounted tanks are great for providing water to grazing livestock, but with multiple paddocks the number of tanks and amount of pipe to be installed can be overwhelming. Portable tanks and tubing allows for expanding water infrastructure without the major expense of permanent installations. The tanks can be moved with the livestock rotation,

which provides a water source near the livestock and minimizes issues of trampling (compaction and mud) that would otherwise occur in areas surrounding permanent tanks.

Portable water tanks and tubing can be moved with an ATV. Tubing is available that is specifically made to be moved regularly as a part of a towable irrigation system (e.g. K-Line Irrigation). This tubing has advantages over common polyethylene tubing in that its special fabrication allows the tube to not hold to a 'memorized' shape. Rather, the tubing conforms to the lay of the land each time it is moved. Portable water line does not provide frost protection, however, and can only be used in above-freezing temperatures. Tubing typically comes in rolls of 300 to 370 feet with tube diameters of 1 ¼ to 2 inches. Rolls of tubing are connected together with cam-lock fittings. The producer can add to the line or shorten it as needed. The fittings used in a portable water system need to be very strong and durable, they should be made specifically for use with towed equipment.



**Figure 10. Portable stainless steel stock tank (K-Line Irrigation). Photo credit Jason Gross.**

Water system design and tube layout follow the same design criteria used with buried PVC pipe. Operational and static pressure at the hydrant must be carefully calculated so the water flow overcomes friction and elevation losses in the tubing. Flow capacities of the water source need to be measured and matched to the

number of livestock. Portable air/vacuum vents should be installed along the length of the tube (Figures 11 and 12). In rough pastures, place air vents at the ridge crests to protect the tube from air locks and vacuum problems. Depending on the water flow, pressure, and the topography, up to 3,000 feet of surface tubing is possible.



**Figure 11. K-Line 1 1/4" tube connected to water hydrant with a Waterman AVP 1 air vent in the pod. Connections made using cam-lock fittings along the length of the tube. Photo credit Jason Gross.**





**Figure 12. Close-up of portable air/vacuum vent within protective pod. Photo credit Jason Gross.**

Normally the tubing is connected to a hydrant and water is supplied under pump pressure, but water can also be supplied as a gravity system using a large tank or cistern. The water level in the cistern or source tank must be at least 10 feet higher than both the highest crest of the tube and maximum elevation of water in full stock tanks. The tube will have to be well vented and the inlet riser from the cistern tank may need a gravel filter to prevent issues with excessive algae or debris. Cisterns can be made from existing stock tanks at windmills or solar wells or using poly tanks like those used for fertilizer storage.

Portable water tanks have limited capacity compared to conventional stock tanks. To accommodate quick and easy moves with an ATV, portable tanks may only store 20-30 gallons of water. The pasture system needs to provide adequate reserve to manage a pump or well

failure. Large permanent tanks should be located near the livestock somewhere in the pasture or field. For extra storage in pressure or gravity systems a portable cistern can be made from 1,000 or 1,500-gallon nurse tanks on running gear. These storage cisterns can also be moved with the cows and portable tanks.

Water and fence infrastructure is a large and necessary expense for any grazing operation. Like most agricultural systems, there are many options to choose from. If the grazing practice has frequent paddock moves then the cow or calf behavior will be more supportive of alternatives such as portable fence and portable water systems. These alternatives are available and can be installed using simple construction techniques. The flexibility of electric fence and portable water can be adapted to grazing crop fields and complements portable and barbed-wire fencing.

## Water system design basics

The physics of water flowing through a pipe, especially gravity systems, is very complex. Water flowing through a pipe has to overcome friction losses, elevation loss or gain, air and vacuum problems, and other potential issues. This section provides a very basic method of designing a short, pressurized water line; however, it is best to have an experienced design professional assist in the layout and design. The design will determine the well capacity needed to supply the livestock water needs and the required tube diameter, and check elevation pressure loss or gain.

Total dynamic head (TDH) is the equivalent height (feet) that the water would have to be lifted (pumped) to account for friction and fitting losses in addition to the actual elevation change. Pressurized water in a pipe or pressure tank has the energy potential to move water like the elevated water in a town's water tower has the potential to distribute water to residences; the energy is just in a different form. The potential energy of elevated water can be converted from feet to psi in a pressurized line and vice versa. For water, 1 psi of pressure = 2.31 feet of elevation rise. A column of water that is 231 feet high will register 100 psi on a pressure gauge at its base. In a typical pressurized water system, the measured static water pressure at a water hydrant will need to be converted to feet of head. For example, 50 psi at the hydrant = 115.5 feet of head (50 psi x 2.31 ft/psi). In this example, a hydrant with a static head pressure of 50 psi could lift water in a pipe 115.5 feet high if there were no energy losses. In real situations, the actual elevation rise will be less due to the friction loss of the pipe and also minor losses.

Even though water is a lubricant there is energy loss through friction. Review Table 3 to estimate the friction loss for polyethylene tubing. Find your desired or measured flow rate (Q) in gpm using the left-most column and then move to the right to find the friction loss per 100 feet of length for differing sizes of tubing. If you would like to install 1 ¼-inch tubing with a flow rate of 8 gpm, then you would get a friction loss of 1.157 ft per 100 ft, which means that there is 1.157 feet of head loss per 100 feet of tubing. If your desired portable water tubing is to be 1,000 feet long, then the friction loss in the pipe can be determined as (1,000 ft /

100 ft) x 1.157 ft = 11.57 feet. This means that pushing 8 gpm of water through 1,000 feet of 1 ¼-inch tubing at 50 psi would reduce the height you could lift the water by 11.6 feet (115.5 ft – 11.6 ft = 103.9 ft).

It's important to consider the effect of water velocity on friction and minor losses and how the desired flow rate is achieved. As water velocity through tubing increases, friction losses increase at an even higher rate. Water flow rate depends upon the diameter of the tubing and the water velocity. At a constant flow rate, as the tube size gets larger the water velocity and resulting losses decrease. Another reason to think about water velocity is that water velocity can be dangerous when it exceeds 5 feet per second (indicated by the area of Table 3 that refers to "v > 5 fps"). There is a phenomenon called 'water hammer' that may occur when water flowing in a pipe suddenly stops and there is an instant surge in water pressure. This sudden surge can exceed the bursting pressure of the pipe or tube and cause a failure of the tubing. The faster the water velocity, the greater the risk for water hammer. Valves in the pipeline must be turned off slowly and care must be taken to keep debris from causing a sudden blockage in the pipe. To have minimal risk for water hammer, the tube size should be at least the next size larger than the minimum size listed with v < 5 fps. Larger-diameter tubing and fittings are more expensive, but there are good reasons to not undersize tubing.

Minor losses also deserve attention in the design of a water system. Minor losses account for energy loss as water flows through fittings, valves, or any interruptions to water flow. Minor loss tables for specific fittings and valves can be found on the internet, but in general, it is conservative to use 0.5 foot of loss per fitting, valve, and cam-lock connection in the tubing.

The last loss to measure accounts for elevation losses or gains. It takes energy to push water up a hill, as illustrated in Figure 13, but when the water line goes downhill it gains energy (pressure). Surveying the elevation path for tubing can be done fairly simply with topographical maps or GPS. Record the hydrant elevation, elevation of any peaks or valleys of the tubing path, and then make a cross-section graph such as shown in Figure 14.

**PE PIPE, SIDR-PR  
FRICTION LOSS ft/100 ft**

Q (gpm)	1/2 inch 0.622 ID	3/4 inch 0.824 ID	1 inch 1.049 ID	1-1/4 inch 1.380 ID	1-1/2 inch 1.610 ID	2 inch 2.067 ID	2-1/2 inch 2.469 ID	3 inch 3.048 ID
2.0	4.3052	1.0943	0.3377	0.0888	0.0419	0.0124	0.0052	0.0019
4.0	15.5401	3.9501	1.2189	0.3205	0.1513	0.0448	0.0189	0.0068
6.0	32.9268	8.3695	2.5825	0.6792	0.3206	0.0949	0.0399	0.0143
6.5	v>5 fps	9.7067	2.9952	0.7877	0.3718	0.1101	0.0463	0.0166
7.0	v>5 fps	11.1346	3.4358	0.9035	0.4265	0.1263	0.0531	0.0190
7.5	v>5 fps	12.6520	3.9040	1.0267	0.4846	0.1435	0.0604	0.0216
8.0	v>5 fps	14.2582	4.3996	1.1570	0.5461	0.1617	0.0681	0.0244
8.5	v>5 fps	15.9523	4.9224	1.2945	0.6110	0.1809	0.0761	0.0273
9.0	v>5 fps	17.7334	5.4720	1.4390	0.6792	0.2011	0.0846	0.0303
9.5	v>5 fps	19.6009	6.0482	1.5905	0.7507	0.2223	0.0936	0.0335
10.0	v>5 fps	v>5 fps	6.6509	1.7490	0.8256	0.2445	0.1029	0.0369
11.0	v>5 fps	v>5 fps	7.9347	2.0867	0.9849	0.2917	0.1227	0.0440
12.0	v>5 fps	v>5 fps	9.3220	2.4515	1.1571	0.3427	0.1442	0.0517
13.0	v>5 fps	v>5 fps	10.8115	2.8432	1.3420	0.3974	0.1672	0.0599
14.0	v>5 fps	v>5 fps	12.4018	3.2614	1.5394	0.4559	0.1918	0.0688
15.0	v>5 fps	v>5 fps	14.0920	3.7059	1.7492	0.5180	0.2180	0.0781
16.0	v>5 fps	v>5 fps	v>5 fps	4.1764	1.9713	0.5838	0.2457	0.0881
17.0	v>5 fps	v>5 fps	v>5 fps	4.6726	2.2055	0.6531	0.2749	0.0985
18.0	v>5 fps	v>5 fps	v>5 fps	5.1943	2.4517	0.7260	0.3055	0.1095
19.0	v>5 fps	v>5 fps	v>5 fps	5.7413	2.7099	0.8025	0.3377	0.1210
20.0	v>5 fps	v>5 fps	v>5 fps	6.3134	2.9799	0.8825	0.3714	0.1331

PE MATERIALS AND PRESSURE RATINGS

Material	SIDR	PR (psi)	72% PR (psi)
3408	15	100	72
3306 & 3406	15	80	58
3408	11.5	125	90
3306 & 3406	11.5	100	72
3408	9	160	115
3306 & 3406	9	125	90
3408	7	200	144
3306 & 3406	7	160	115
3408	5.3	250	180
3306 & 3406	5.3	200	144

Hazen-Williams C = 135  
 ASTM-D-2239, PE Pipe  
 Pressure Rating (PR ) @ 73 F varies with pipe material

**Table 3. Friction loss table for polyethylene tubing (Missouri Livestock Watering Systems Handbook, Chapter 5).**



**Figure 13: Tubing path showing the water tank and hydrant locations. Photo credit Jason Gross.**

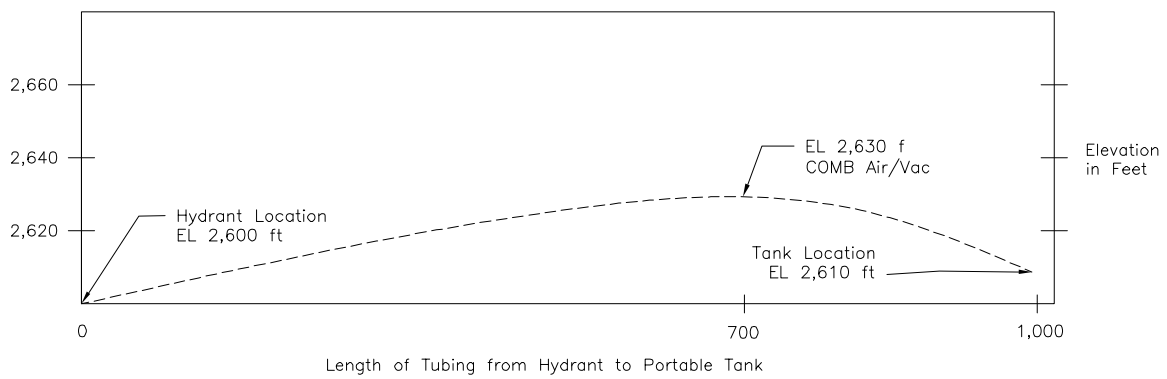

**Figure 14. Cross-section view of tubing elevation path.**

The next consideration is the use and position of air/vacuum vents and combination or 3-way valves (Figure 14). An air/vacuum vent is a simple attachment to a pipeline that allows air to be released as the pipe is filled with water or to allow air in while the pipe is draining or during normal operation to prevent a vacuum that could collapse the pipe or tubing. Combination valves or 3-way valves have the same function for air and vacuum release, but also can release small air pockets that can develop while water is in the pipe. All groundwater has small amounts of gases in it. As water flows over a rise, the water velocity slows down and may reach a point where gas bubbles can form and cause an air lock. This air lock can act as a blockage and not allow water to flow to the tank. Combination valves should be installed into tubing cam-lock connection points at every rise of 20 feet or more in elevation. An air/vacuum vent must also be installed at the hydrant. If this isn't done, then the tubing must be disconnected from the hydrant while closing the hydrant valve to let air into the tubing. If the valve at the tank is self-venting then an air/vent is not necessary.

#### Flow and hydrant pressure measurement

The capacity of the well in terms of flow rate is a major determining factor in the management of grazing cattle. Water consumption for cows or calves could reach as high as 20 gallons per day per head, but the timing of when cattle drink is also important. A paddock with large-volume permanent stock tanks does not require a high flow rate to keep up with cattle drinking the water, which accommodates longer recovery times with lower-flow water supply. A good resource for recommended well flow capacities and recovery times for permanent tanks can be reviewed in the Nebraska NRCS engineering guide "Nebraska Stockwater Pipeline Handbook" Chapter 2.

Portable tanks are a different story. The advantage of a portable tank is that it can be moved easily with an ATV. Producers don't have to wait to drain a large tank and then use a loader or a truck to move the tank. This ease of handling allows a producer to frequently (e.g. daily) move tanks to new locations. By frequently moving tanks, there will be a better spread of manure in the paddocks, less area around tanks torn up by cattle,

and less mud and fewer flies that can lead to disease. The major disadvantage of a portable tank is the lack of capacity. Portable water tanks generally do not have enough capacity, in terms of water reserve and water supply flow rate, for all of the livestock to drink at one time. However, use of portable tanks in small paddocks gives easy access for cattle to drink multiple times a day instead of filling the rumen once or twice a day.

For stock tanks that lack multi-day capacity, University of Virginia Extension suggests that the well and delivery system should provide at least 2 gpm of water flow per head of tank capacity (# animals that can drink at one time from the tank). For example, a portable tank with one-time drinking capacity of 2-4 head, needs at least 8 gpm of continuous water flow delivered to the tank. Since there may be multiple water tanks supplied by a common well, the well must be able to supply water to the tanks simultaneously, although each tank may not be fully occupied and require peak capacity. For illustration, for one well to provide water to each of three [2-4 head] portable tanks in a grazing system, the well may have to provide 12-18 gpm (2 gpm/hd x 2-3 hd/tank x 3 tanks) of peak flow in the main distribution line and provide 8 gpm peak flow to each tank when filling individually, while overcoming all the losses (elevation, friction, and minor losses) in the system.

#### How to Measure Flow and Pressure

In developing a grazing program where a new well and buried pipelines will be installed, the necessary flow rates and pressures can be incorporated into the system design. In measuring hydrant capacities there must be an understanding of well and hydrant static pressure and hydrant operating pressure. Static pressure is the measured pressure of the water in the water line and pressure tank when there is no flow. This is stored energy that when a valve is opened the energy is converted into water flow. The higher the static water pressure the more energy in the system to overcome friction, minor, and elevation losses. Hydrant operating pressure is the pressure at the hydrant when a valve is opened downstream of the hydrant. It is measured pressure at the point of the pressure gauge while water is in motion. Since pressure is the restriction of flow, a full potential flow of the hydrant

would indicate a near 0 psi pressure reading (valve fully open). When the tank's valve is nearly closed with minimal flow then the pressure gauge would read near static pressure.

There are two types of pressurized water systems: a variable-pressure pump with a pressure tank (pit or pitless) or a variable-frequency-drive (VFD) pump with a comparatively small pressure tank. Variable-pressure pumps operate within a switchable pressure range, such as 50 – 70 psi. A well with a VFD pump will vary motor speed to keep the water pressure constant as the flow rate changes. Methods for measuring the pressure and flow of these two pump systems are basically the same except that with the variable-pressure pump, measurements need to be made over the pressure range of the pump.

In existing systems the flow and pressure available with older wells and hydrants need to be measured to assess the capacity for filling portable tank. The first step in designing a portable water system is to do a pressure and flow check on each hydrant that will be connected to the surface tubing and portable tank. Pressure is a restriction of flow. For a given system, the higher the operating pressure the lower the flow rate and vice versa. Each hydrant will have different flow and pressure characteristics because the hydrants are at different elevations and different distances from the well. Before purchasing tubing or portable fencing, know the capacity of the well at each hydrant.

Figure 15 shows an assembly for measuring hydrant operating water pressure and flow from a hydrant. The pressure gauge and valve will simulate the flow capacity of the hydrant by adjusting the hydrant flow rate via opening or closing the valve and monitoring the measured pressure with the flow. Closing the valve and restricting water flow simulates the energy used to push the water in the proposed tubing length (friction and minor losses) and elevation loss or gain.

This assembly is relatively easy to construct and to use to measure static pressure at the hydrant and flow rates at specific pressures. To build this assembly you will need:

- fitting from female garden hose to  $\frac{3}{4}$ " pipe
- $\frac{3}{4}$ " tee (female)
- pressure gauge (0-150 psi)
- $\frac{3}{4}$ " threaded male pipe coupling/nipple
- $\frac{3}{4}$ " quarter-turn ball valve, and
- pipe tape or joint compound.

Also needed are a stop watch, 5-gallon bucket, notepad and pencil.



**Figure 15. Assembly for measuring water pressure and flow rate from a hydrant. Photo credit Jason Gross.**

Follow these steps to measure pressure and flow from constant- and variable-pressure wells:

1. Connect the gauge/valve assembly to the hydrant (as illustrated in Figure 15). Make sure other hydrants are not being used.
2. Measure high and low static pressures at the hydrant. Open the hydrant and the valve to let any air out of the system. Then, slowly close the valve and record the pressure. Variable pressure pumps usually have high and low settings with 20 psi ranges (30 – 50 psi or 50 – 70 psi). Open the valve and drain the pressure tank for a while so the well engages. Then close the valve completely and record the pressure. Repeat once the pressure tank reaches high-pressure setting. Note: the difference between pressure at the well and at the hydrant indicates the extent of losses between the well and the hydrant.
3. Measure maximum flow rates. Use a stop watch to record the time it takes to fill a 5-gallon bucket with the hydrant and valve fully open. Use Table 4 to determine the flow rate in gpm. Do this at low and high pressure setting for variable pressure wells. The minimum required flow rate to the tank must be achievable when the switch is at the low pressure setting. When the valve is opened the operating pressure will drop to near

the same pressure for both the low and high pressure settings, but there will be a difference in flow rate.

4. Measure the flow at intermediate pressures. The idea here is to see how the water delivery system responds as the system pressure changes. Open the ball valve and then slowly close it until about 10 psi registers on the pressure gauge. Then, record the pressure and the time it takes to fill the 5-gallon bucket. Repeat at 20 psi and additional 10 psi increments until the valve below the pressure gauge is fully closed. Convert fill times to flow rates using Table 4. A gradual loss of flow until the pressure approaches its maximum at no flow (valve closed) is expected. If flow is noticeably or significantly reduced at low pressure, this is a warning that the water delivery system may not perform acceptably in practice, and any minor restriction or additional system draw may result in cattle not receiving enough water.

When measuring flow rate at the hydrant, there will be some variability in flow based upon whether the pressure tank is being refilled and pressurized by the pump. This variability is usually small and unavoidable.

Fill time (seconds)	Flow rate (gpm)		Fill time (seconds)	Flow rate (gpm)
300	1		27	11
150	2		25	12
100	3		23	13
75	4		21	14
60	5		20	15
50	6		19	16
43	7		18	17
38	8		17	18
33	9		16	19
30	10		15	20

**Table 4. Equivalent hydrant water flow rate based upon time to fill 5-gallon bucket.**

*Example Basic Design*

Here is a walk-through of a basic design for providing water to grazing stocker calves using a portable tank and an existing hydrant. Known values include:

Water tank:

K-Line portable tank  
One-time capacity: 4 calves

Tubing info:

Tube size: 1 ¼” or 1 ½”  
Length: 1,000 ft from hydrant to tank

Elevations @ locations:

Hydrant elevation: 2,600 ft  
Portable tank elevation: 2,610 ft @ 1,000 ft  
Intermediate summit: 2,630 ft @ 700 ft

Well info:

Variable-pressure at 40 to 60 psi  
(This is static pressure at the well)  
Pitless well Whitewater Mfg.

Measured hydrant operating pressure verses flow at hydrant (Figure 14):

10 psi: 18 gpm  
20 psi: 16 gpm  
30 psi: 14 gpm  
40 psi: 12 gpm  
50 psi: 8 gpm

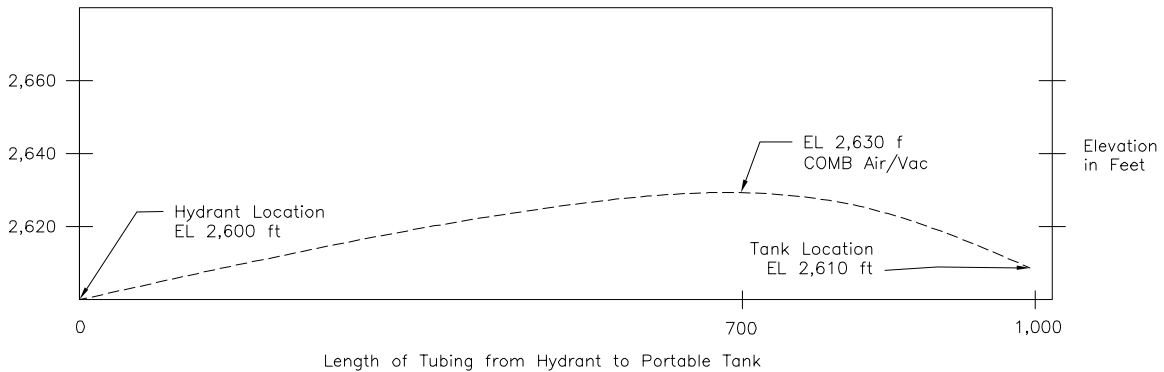

1. Calculate minimum required flow rate

Peak demand at tank = 4 calves x 2 gpm/head = 8 gpm

This means minimum required supply to the tank = 8 gpm

2. Evaluate Total Dynamic Head (TDH) at minimum required flow rate

In this example there is only one hill or summit in the layout. In some installations, the length of tubing may traverse several hills and valleys between the hydrant and tank. Each major rise or fall must be evaluated for head loss or gain. In this example, the system must provide 8 gpm at the summit of the hill at 700 feet, so we need to calculate friction loss at the tank location (full length of the tubing) and also at the summit for each of the tube options.

Friction loss: Trial 1 using 1 ¼” tubing:

From Table 3, loss is 1.157 ft / 100 ft of tubing at 8 gpm

To the tank: (1,000 ft / 100 ft) x 1.157 ft = 11.57 ft or 11.6 feet of friction loss

To summit: (700 ft / 100 ft) x 1.157 ft = 8.099 ft or 8.1 feet of friction loss



Friction loss: Trial 2 using 1 ½” tubing:

From Table 3, loss is 0.5431 ft / 100 ft of tubing at 8 gpm

To the tank: (1,000 ft / 100 ft) x 0.5431 ft = 5.431 ft or 5.4 feet of friction loss

To summit: (700 ft / 100 ft) x 0.5431 ft = 3.8017 ft or 3.8 feet of friction loss

Minor loss: In this example there will be an air/vacuum vent at the hydrant, a COMB valve at the apex of the hill, three camlock fittings, and the fitting connecting the K-Line tubing to the hydrant, for a total of six flow interruptions. A conservative estimate of minor losses is:

0.5 ft / fitting x 6 fittings = 3 feet of minor loss

Elevation loss or gain: The elevation losses to lift water to the summit and to the tank are:

Summit El. – hydrant El. = 2,630 ft – 2,600 ft = 30 ft of elevation loss at summit

Tank El. – hydrant El. = 2,610 ft – 2,600 ft = 10 ft of elevation loss at tank

Pressure head available at hydrant: In this case, the desired flow rate of 8 gpm is achievable from the hydrant at 50 psi. Convert this pressure to feet of head.

50 psi x 2.31 ft/psi = 115.5 feet of head

Total dynamic head: The total dynamic head left at a given location to move water is calculated by subtracting the losses from the hydrant head pressure.

TDH = Head at hydrant – Friction loss – Minor loss – Elevation loss or gain

Trial 1: using 1 ¼” tubing

At the tank: 115.5 ft – 11.6 ft – 3 ft – 10 ft = 90.9 ft,

which at 2.31 ft/psi = 39.35 psi or 39 psi at the tank

At the summit: 115.5 ft – 8.1 ft – 3 ft – 30 ft = 74.4 ft,

which at 2.31 ft/psi = 32.2 psi or 32 psi at the summit

Trial 2: using 1 ½” tubing

At the tank: 115.5 ft – 5.4 ft – 3 ft – 10 ft = 97.1 ft,

which at 2.31 ft/psi = 42.03 psi or 42 psi at the tank

At the summit: 115.5 ft – 3.8 ft – 3 ft – 30 ft = 78.7 ft,

which at 2.31 ft/psi = 34.07 psi or 34 psi at the summit

In this case, we don't see much difference between the two tubing sizes (Trial 1 vs. Trial 2). This may be due in part to selecting tubing that is at least two sizes larger than the minimum size (¾” from Table 3). It is recommended to have a minimum of 10-15 psi available at a COMB air/vacuum vent and at the tank even though most COMB air/vacuum vents have a working range of 2 – 150 psi. In this case, we are well above the minimum at both locations, so either size of tubing will work. In order to complete the design a review of flow performance will have to be completed at the low side of the pressure switch.

### 3. Evaluate Total Dynamic Head (TDH) at low-pressure setting

If the well is variable-pressure, then evaluate the TDH available at the low pressure setting (40 psi at the pressure tank). The system needs to function acceptably in the lower pressure range and higher flow rate. There is pressure loss in the system as water travels from the pressure tank to hydrants. This loss is normally determined as the difference in tank and hydrant static pressures. For this example, let's assume this loss is 10 psi or that the static pressure is 30 psi at the hydrant when the pump is switched to the low pressure setting (40 psi – 10 psi = 30 psi). At 30 psi, the flow rate from the hydrant is around 14 gpm, which leads to the following new friction losses:

Friction loss: Using 1 ¼" tubing:

From Table 3, loss is 3.2614 ft / 100 ft of tubing at 14 gpm

At the tank:  $(1,000 \text{ ft} / 100 \text{ ft}) \times 3.2614 \text{ ft} = 32.614 \text{ ft}$  or 32.6 feet of friction loss

At the summit:  $(700 \text{ ft} / 100 \text{ ft}) \times 3.2614 \text{ ft} = 22.830 \text{ ft}$  or 22.8 feet of friction loss

Pressure head available at hydrant: Now, 14 gpm from the hydrant is achievable at 30 psi.

Converting this pressure to feet of head:

$30 \text{ psi} \times 2.31 \text{ ft/psi} = 69.3 \text{ feet of head}$

Total Dynamic Head (TDH) – Using 1 ¼" tubing

At the tank:  $69.3 \text{ ft} - 32.6 \text{ ft} - 3 \text{ ft} - 10 \text{ ft} = 23.7 \text{ ft}$ ,

which at 2.31 ft/psi = 10.26 psi or 10 psi at the tank

At the summit:  $69.3 \text{ ft} - 22.8 \text{ ft} - 3 \text{ ft} - 30 \text{ ft} = 13.5 \text{ ft}$ ,

which at 2.31 ft/psi = 5.8 psi or 6 psi at the summit

The recommended pressure minimum for the tank valve and the COMB valve is 10 – 15 psi. The low critical valve pressures calculated for this scenario suggest that the system would barely function with the hydrant delivering 30 psi and 14 gpm.

Friction loss using 1 ½" tubing at 30 psi and 14 gpm:

From Table 3, loss is 1.5394 ft / 100 ft of tubing at 14 gpm

At the tank:  $(1,000 \text{ ft} / 100 \text{ ft}) \times 1.5394 \text{ ft} = 15.394 \text{ ft}$  or 15.4 feet of friction loss

At the summit:  $(700 \text{ ft} / 100 \text{ ft}) \times 1.5394 \text{ ft} = 10.776 \text{ ft}$  or 10.8 feet of friction

Total Dynamic Head (TDH) - Using 1 ½" tubing at 30 psi and 14 gpm:

At the tank:  $69.3 \text{ ft} - 15.4 \text{ ft} - 3 \text{ ft} - 10 \text{ ft} = 40.9 \text{ ft}$ ,

which at 2.31 ft/psi = 17.7 psi or 18 psi at the tank

At the summit:  $69.3 \text{ ft} - 10.8 \text{ ft} - 3 \text{ ft} - 30 \text{ ft} = 25.5 \text{ ft}$ ,

which at 2.31 ft/psi = 11.04 psi or 11 psi at the summit

At the low pressure setting, the 1 ½" tubing provides 5 psi more reserve at the summit than the 1 ¼" tube. With reserve of 11 psi instead of 6 psi, the COMB air/vacuum vent at the summit would be more likely to perform as expected. Note that the water flow rate to the tank will only reach its potential of 14 gpm when the tank valve is fully open (i.e. tank is refilling after being emptied or cattle have quickly lowered the water level). Most of the time the system would operate at a lower flow rate since as the cattle drink the valve will crack open and fill the tank. If the valve manages to compensate flow for how fast the cattle are drinking, then we would expect a much lower flow rate (8 gpm or less). This would indicate that the 1 ¼" tubing would work fine. Care and good judgement must be used to determine tube size. Other options would be to not have the tubing on top of the summit but to go around it at a lower elevation or to use 1 ½" for part of the line starting at the hydrant to the summit and then switch to 1 ¼" tubing. Dynamics in portable water systems can make the design rather difficult at times.

### Moving surface tubes and portable tanks

It is essential that the equipment selected for providing water to intensive grazing areas be very portable and designed for the intended use. Moving tubing and portable tank needs to be simple to do with an ATV or other utility vehicle. The portable tank shown in Figure 16 can be moved while the tubing is still connected and pressurized; the tow hook on the stainless steel tank is simply connected to the ATV and the tank is ready to move.

A little foresight when laying out paddocks and extra care when moving tanks should minimize flow problems and maximize tube life. When tanks are

moved, make sure that the tubing won't cross itself so that it could pinch itself off. With a little practice, moving tubing from one paddock to the next should become very simple.

Sometimes, narrow gates, roads, or other obstructions can complicate the move. In these situations, it may be quicker and easier to disconnect the tubing at the cam-lock connections and tow the individual sections. In Figure 17, sections of tubing have been secured to be towed through a narrow gate. A simple clove hitch connection with a rope is a quick and easy way to secure tubing for transport. Always use a rope or a strap and not a chain to move tubing. Chain or cable will girdle the tubing and damage it.



**Figure 16. Portable tank about to be towed to a new location. Photo credit Jason Gross.**



**Figure 17. Securing tubing with a tow rope and clove hitches. Photo credit Jason Gross.**

## 5. Irrigated Pasture Development

Irrigating grasses and forages can be a complex subject due to the variation from one location to another. What works for western Nebraska may not be a good practice in eastern Nebraska. The irrigation machinery, climate, soils, and availability of water are so diverse just across Nebraska that it is unwieldy to cover them in depth in this publication, so basic ideas and examples are provided here. Obtain local information from extension specialists, publications and other reputable resources. Publications that are often helpful include NebGuide G1502, “Perennial Forages for Irrigated Pasture”, NebGuide G2012, “Forage Production with Limited Irrigation”, and University of Missouri Extension publication, “Forage Crop Irrigation Systems and Economics”.

Irrigation can be a tremendous asset to a grazing operation. According to research in Missouri, irrigation response to dryland grass for cool-season perennial grass is 450-700 lbs. of dry matter per acre-inch of water applied and 600-1,000 lbs. of dry matter per acre-inch of water applied for warm-season grasses. University of Nebraska research conducted near North Platte (west-central Nebraska) shows that up to 8 tons per acre of dry matter can be grown in ideal conditions.

Though irrigation can be a great asset to a grazing operation, there are some disadvantages – primarily due to the added infrastructural costs such as wells/pumps, power unit, water pipelines, and the application system. Irrigation water can be applied by several methods, including variations of flood, sprinkler and subsurface systems. Flood or surface irrigation systems are prevalent in many areas that accommodate moving water uniformly across a field by gravity, though these systems are less commonly selected for new installations due to their lower water-utilization efficiencies. Flood irrigation is generally used with row crops, so there’s not much use in perennial pastures, but there may be some application for grazing of cover crops. Sprinkler systems need more power to distribute water under pressure, but they offer much better control of water application,

which can help optimize forage production, conserve water, and minimize runoff. Sprinkler systems are most commonly selected for grazing applications. Subsurface systems are growing in popularity, but are still a small share of systems installed, limited primarily to use with high-value crops and/or land, and areas with water restrictions. Irrigation systems may require additional labor and with the added land valuation there may be an increase in property taxes. Carefully consider the likely benefits of adding irrigation and research the costs to install, operate and maintain a system. Inquire about local or state regulations – some areas have restrictions on installing or improving wells – before getting very far into planning.

Irrigation of grasses and grazed annuals will typically be provided by a sprinkler (pressure) system; through a center pivot, laterals, or a towed system. In many areas center pivots are a very popular irrigation system; they can be a full circle or a wiper pivot. Towed systems include pods, tow lines, or side rolls.

Irrigated grass also can have benefits in areas that have limited irrigation. Grass production is tied with available moisture and fertility. In limited irrigation areas in times of dry weather, peak grass production may not be achieved or desired. In these situations it may be best to focus the available water on only a portion of the irrigated acres to maximize production there instead of having marginal yields across the field. Perennial grasses can go into drought-induced dormancy and recover later in the year when more water is available. Another option in limited irrigation areas is to plant cool-season grass in a portion of a field and warm-season grasses in the remainder.

Another important issue with grazing irrigated grasses is surface compaction. Grass sod is usually resistant to soil compaction in normal grazing conditions. Healthy, deep-rooted grasses will resist compaction unless the area receives excessive moisture or is over-grazed (cattle in one spot too long). It is best to not irrigate for at least 2 days prior to introducing cattle to the paddock. If fields become chronically wet during

rainy periods, then cattle need to be moved between paddocks more often or to a different field or a feedlot. Knowing field soil types and how quickly soil will dry will help a producer manage during these times.

### Center Pivots

Center pivots are a great irrigation system for crops but they provide difficulties in grazing systems. In dry conditions it is important to irrigate a paddock immediately after being grazed, as this helps kick-start vegetative growth. A paddock should never be irrigated while being grazed or just prior to grazing, as this increases the risk of soil compaction. Also, with conventional permanent stock tanks, cross-fences are generally perpendicular to the pivot tracks, leading to each paddock being the shape of a pie wedge. This geometry makes it difficult to subdivide paddocks and

encourage uniform grazing. It also means that the pivot will have to drive over several fences. Break-away posts are expensive, and when the pivot tires pin the wire to the ground it causes a short in the electric fence and weakens the fence. When fence wire is pinned down, livestock may walk over the wire.

Fencing in circles can be difficult, which can limit fence layout and cattle and irrigation management, but with portable water and fence there are options for laying out fence that can balance proper grazing and irrigation. The drawing in Figure 18 shows concentric permanent cross fences that are parallel to the pivot tracks, so no cross fence is driven over by the pivot. Within each ring, internal cross-fencing can be constructed with poly-braid wire and portable posts. Water is supplied using surface tubing and portable tanks.

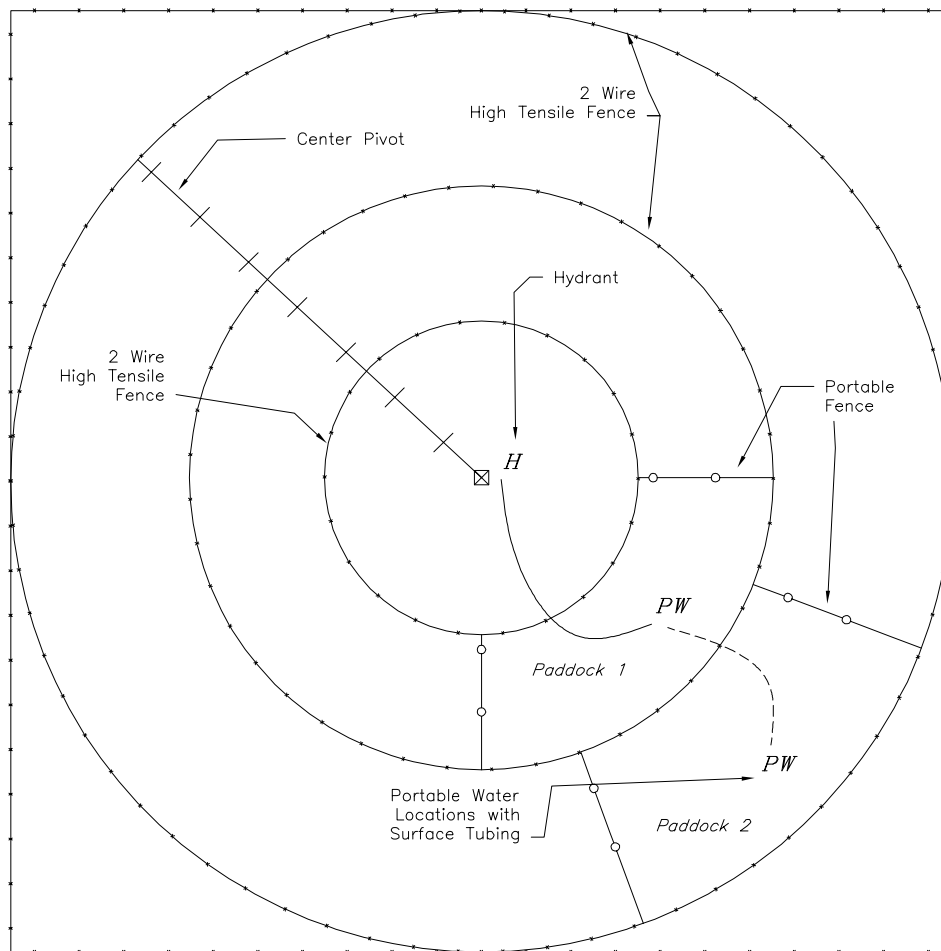

**Figure 18. Fence layout and portable water tank locations for grazing a center pivot-irrigated field.**

With center pivot or wiper pivot systems, irrigation and grazing should be managed in irrigation zones (sectors of a circle as shown in Figure 19) to manage soil moisture while providing adequate grass recovery time (e.g. 45 days) before cattle come back to the same paddock to graze. While cattle graze paddocks in one zone, the pivot can still irrigate the remainder of the field. In Figures 18 and 19 the paddock layout with the concentric cross fences can easily be developed into 3 or 4 zones. Livestock can graze in Zone 1 (Figure 19) while other zones are irrigated. Once livestock and actively grazed paddocks shift from Zone 1 into Zone 2, the center pivot can be moved into Zone 1 for immediate irrigation.

Irrigating perennial grasses that are grazed requires different management of irrigation than does irrigating a full pivot circle of a crop like corn. The corn will generally be the same age and maturity, which means irrigation is required at the same time,

if not at the same rate. Irrigation specialists design center pivots to match the peak demands of typical crops in that region, but with grazed grass, the demands will be different. Grazing keeps the grass in the vegetative stage or at least delays the reproductive stage, which means plants will have very different levels of maturity and water requirements. Breaking a field into zones to graze and irrigate can be helpful.

Zone management can also give the advantage of planting more than one perennial crop under the pivot. Typical irrigated pastures are cool-season grasses, but consider the benefits of having a couple of zones of cool-season grass and the remainder in warm-season grass or annual forages. Additionally, planting a warm-season pasture into a current cool-season pasture splits the water demand for grass growth. The combination of portable water and portable fence allow a producer to graze cattle in crop fields without building permanent tanks and

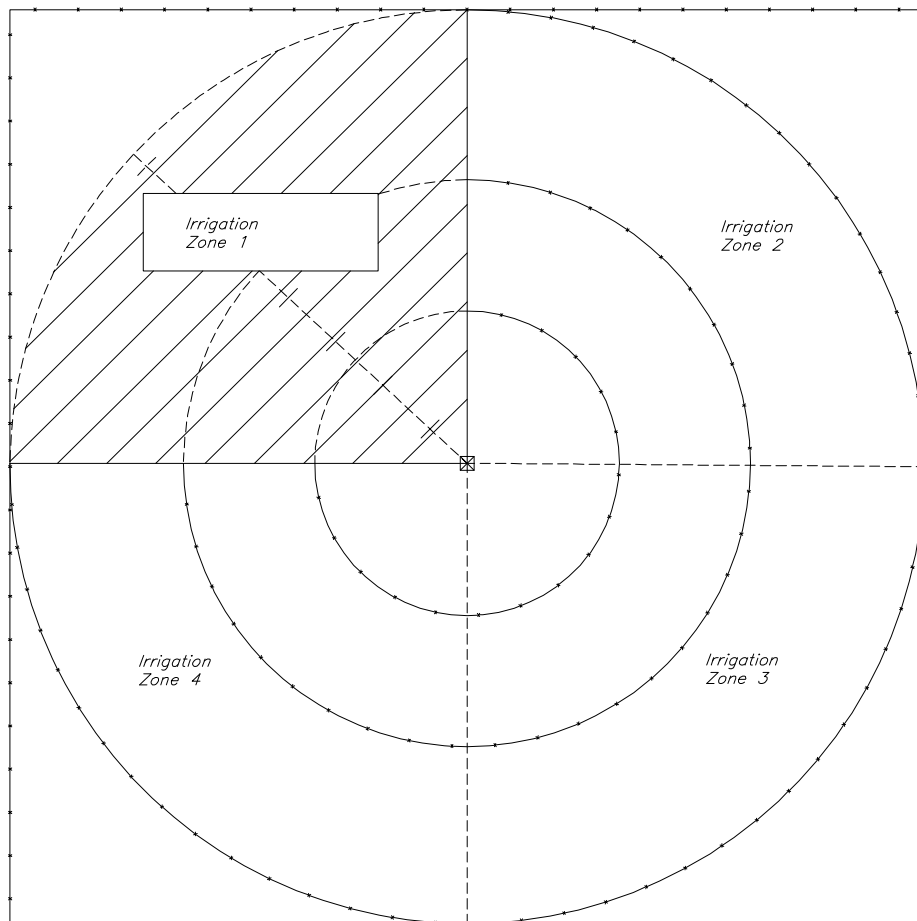

**Figure 19. Irrigation zones facilitate management of grazing paddocks and center pivot irrigation.**

fence systems. Having both pasture and field crops under irrigation diversifies an operation and allows a producer to have forages or crop residues available when needed by cattle. This may be part of a drought management plan, or for a stocker calf operation it can allow the producer to adjust forage available for grazing to the number of calves.

Towed systems

Towed irrigation systems function in a much different manner than pivots, which leads to different fence layouts because the fields and paddocks are generally laid out as rectangles or squares (Figure 20), instead of segments of a ring or sectors of a circle. Fencing and drover's alleys are much simpler to install with towed systems, and paddocks are easier to design and manage than with center pivot systems. Towed systems also work well in irregularly shaped fields.

Figure 20 illustrates a 160-acre quarter-section field laid out for grazing and for irrigation with a towed system. Each of the sixteen paddocks shown in this layout has its own six-position line of sprinkler pods (Figure 21). By using a system that is designed to apply water at a much-slower rate, 12-24 hours depending on soil infiltration rate and water-holding capacity, applied water has time to infiltrate into the root zone and be utilized by the plants instead of running off the field. Each distribution line of pods can be moved within a paddock to a position that achieves the desired water application. Some systems (e.g. K-Line) can be moved while applying water, so the wells don't have to be shut down for each shift. With a proper design for the nozzle application rate and soil water-holding capacity, the field can be fully irrigated in 3 to 6 days.

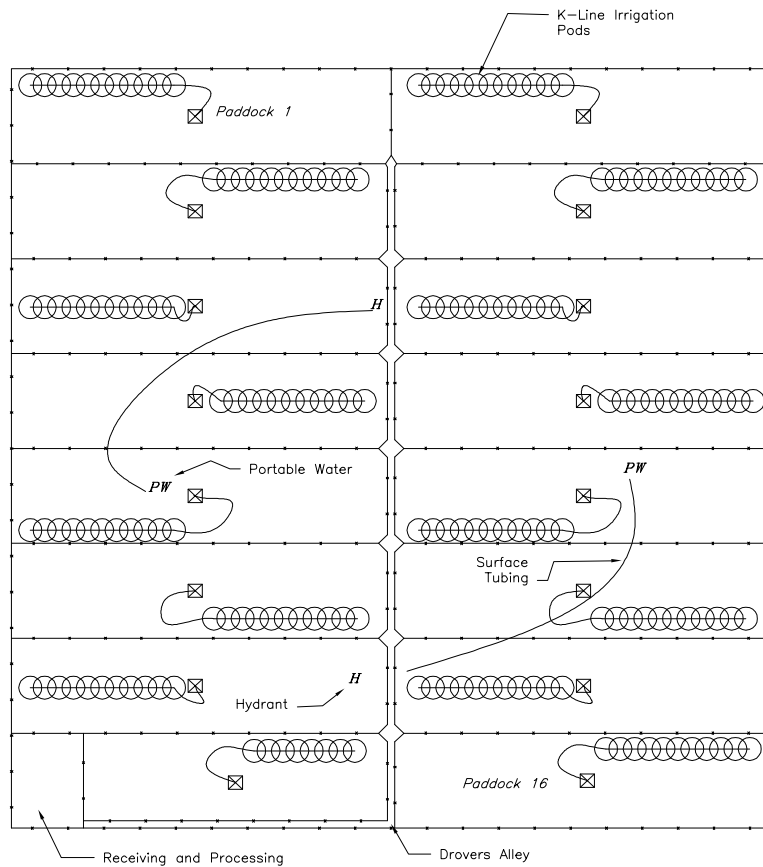

**Figure 20. Paddock layout for a towed irrigation system utilizing sprinkler pods (K-Line Irrigation). "H" shows water hydrant locations and "PW" shows portable stock tank locations.**

Paddocks that are being grazed or about to be grazed should not be irrigated, as the likelihood of compaction increases with grazing of wet or damp soils. Well drives that are designed to deliver a fixed flow of water, like many common electric motors, can create challenges when wanting to operate an irrigation system at partial capacity. Shutting off lines reduces the water flow rate and increases the pressure. Excessive pressure can damage the pump and/or rupture pipelines. Use of a variable-frequency drive (VFD) or engine drive allows as many lines to operate as are within the capacity of the pump and drive unit. Use of a VFD or engine drive allows an operator to apply water only when and where it is necessary. These types of wells are a good option for those in limited irrigation districts or having other restrictions on the amount of water that may be applied.

Portable water and fence systems can really expand the opportunities for irrigated grazing and forage management by accommodating more paddocks and water source options without the physical infrastructure and associated costs of traditional irrigated pasture systems. Cross fences can be 1- or 2-wire permanent or portable fencing and only a couple of hydrants with permanent tanks need to be installed; the remainder of the water delivery system can be portable. This can help lower installation costs. The paddocks can be constructed with alleyways to aid in accessing paddocks and moving cattle from one paddock to another or to a handling area for treatment.



**Figure 21. Towable sprinkler irrigation pods in use. Photo credit Jason Gross.**



# 6. Planning Considerations for Grazing Multiple Crops

One of the main advantages of portable water and fence is the ability to tie different enterprises of a farm together under one grazing/feeding program. Allowing cattle to harvest planted crops instead of mechanically harvesting the crops and feeding in a feedlot provides opportunities to significantly lower the cost of feed production and cost of calf gain. Year-round grazing can be achieved using strategies of perennial grass, rangeland, summer annual forages, spring annual forages, winter annual forages, windrow grazing, bale grazing, crop residue grazing, and some supplemental feeding (Figure 22).

Many livestock operations enjoy the convenience of a feedlot to manage calves, but feedlots come with much expense. Feedlots can involve the construction of pens and bunks and also environmental structures such as diversions, sediment basins, and holding ponds or vegetative treatment systems. There may also be expenses for nutrient management plans, environmental reporting, and state or federal operating permits. Well-managed grazing allows an operation to lower construction costs, reduce environmental issues with feedlot runoff, and reduce the amount of time and labor spent removing and spreading manure. Less time

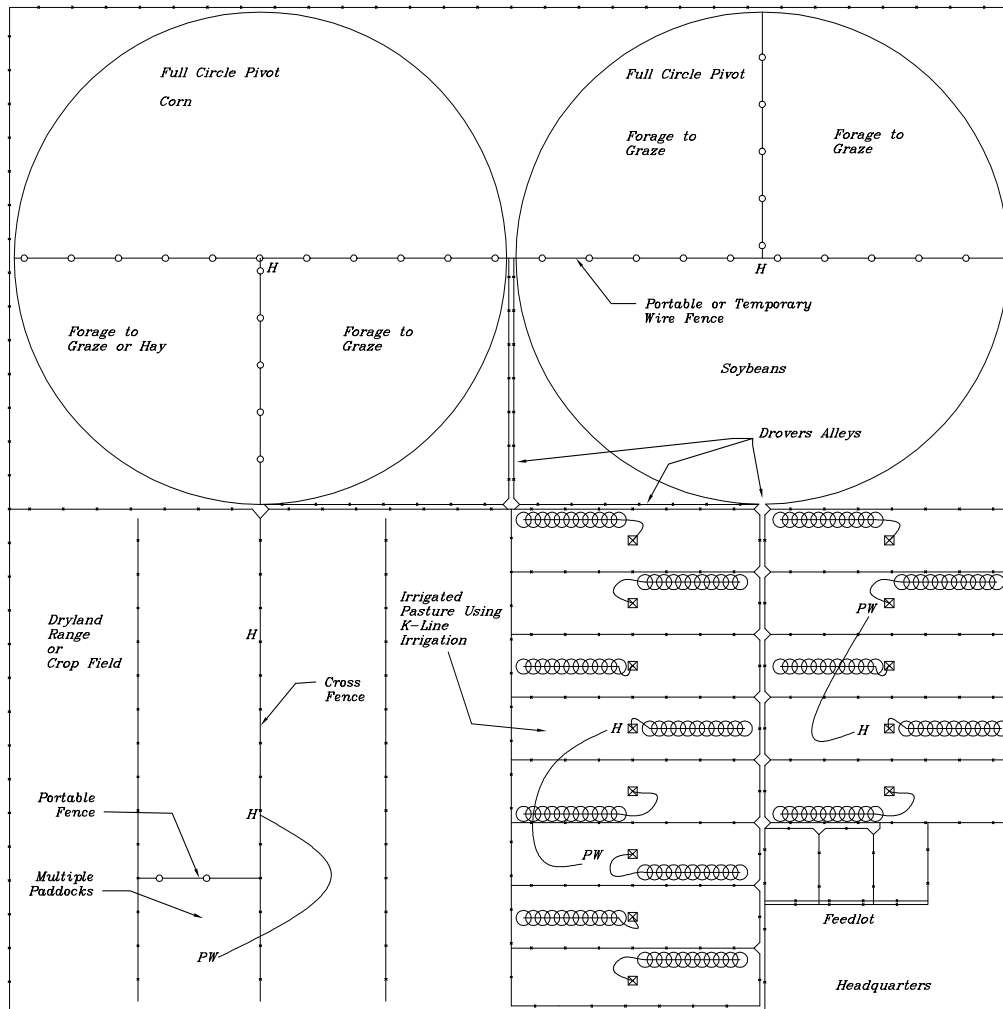

**Figure 22. Example layout of a grazing system that utilizes irrigation, forages, and a small feedlot.**

and machinery will be used in haying, transporting forages, feeding, and hauling manure. Instead, much of the farm's labor and management time will be directed toward planting forages, managing irrigation, and managing cattle.

Figure 22 shows a generalization of an irrigated farm with some dryland crops or rangeland on a section of land (640 acres). This farm will utilize a small feedlot for receiving calves or as a temporary feeding area for calves or cow-calf pairs in times of inclement weather or lack of forage to graze. The diversification of this farm in terms of dryland or irrigated acres and also the production of irrigated forages and commodity crops need to fit the number of animals, their daily consumption rate, forage yields, and forage harvest scheme.

The diversification of the operation illustrated in Figure 22 helps prepare it for overcoming times of trouble. Many weather extremes such as drought, chronic wet periods, hail, early or late freezes, can make producing consistent yield and supply of forage challenging. A producer must be prepared for any inconsistency. In this example, the farm can adapt with many of these problems via irrigation, supplemental feeding, grazing stockpiled forage, or stockpiling irrigated grass. A 10-day planter delay in a field can disrupt the starting date for grazing. What do we do with the cattle for that time period? Should you feed in the feedlot or should you graze stockpiled grass? What type of forages should you plant and when? What forages are best for grazing compared to stockpiling forage? What method of stockpiling, such as building windrows or bale grazing, will work best? The answers to these and other questions likely vary by location and operation. Your local Extension office can offer guidance on planting dates, predicted yield, and varieties that work well for your area. If an operation wants to graze more or less year-round on grass and crop acres, then there will have to be multiple crop species and planting dates.

The dates for planting, starting to graze, and ending grazing have to be very carefully planned. Generally it is best to begin and end grazing a crop before it reaches the reproductive stage or maturity. When planning grazing of annual crops, target for a grazing period of 4 weeks or less. Look at your grazing period in terms of

a month at a time. Experience in planting and grazing crops helps refine these planning considerations, especially since growing and grazing conditions are different every year.

Within the 4-week period of grazing a given crop, paddocks and fields can be subdivided with portable fence so most of the crop can continue to grow and what has been grazed can have an opportunity to regrow or be reseeded. Balance the amount of forage that the calves or cows will need to consume while grazing in each area with the expected yield and amount that can be harvested. Grazing small areas of a paddock or field for short windows of time helps keep a consistent supply of quality forage in the cattle's diet. Unless grazing the seed heads is specifically desired, start and end grazing prior to bud formation or other signs of entering the reproductive stage. Plan to have the next field or crop ready to graze when the current one is finished. This means that the second field will have to have been planted roughly 30 days after planting the first field or have a later-maturing crop. If the timing is off and the next field is not ready to graze, then the producer will have to rely on the backup plan, such as grazing extra pasture or feeding stockpiled forage. Planning of planting and grazing dates can get quite detailed when using a mix of winter annuals, spring annuals (which can also be planted in the summer or early fall), and summer annuals, or several different mixes. It is best to start out with simple mixes and plans so that experience can be developed in what works and what does not, and then adjust and refine the plan as you build experience.

'Harvest ability' in grazing forages is rarely mentioned, but it can be the most important factor in reducing the cost of gain or cow maintenance. It does no good to take the time and expense to grow a lot of forage, and then have the cattle trample or lodge most of it, unless the trampled residue is intended to help protect the soil. Harvest ability depends upon the height of the forage leaves, the stem, and the calf or cow. Twelve-foot-high sorghum being grazed by cows or calves will have most of the yield lost through trampling; the forage should have been grazed earlier. More forage could have been harvested (in pounds per acre of dry matter) earlier in the season at a much shorter plant height, even though

the plant yield at grazing would have been much lower. Shorter crops, such as winter annuals or brassicas, will produce lower yields, but deliver much higher harvest rates when grazed. On the other hand, care must be taken to not remove too much forage, which can contribute to erosion and reduce soil health. Grazing plans need to consider what amount of residue should remain after grazing to avoid erosion and other over-grazing challenges. The field of corn inter-planted with beans and millet shown in Figure 23a presents tall forage having a high yield to graze with cows; but notice the residue that remains after grazing (Figure 23b). Since the corn and soybeans were planted in 30-inch rows, the cows had avenues to roam through the field without much trampling. If these crops were drilled in 7.5-inch rows, then the field would have to have been grazed earlier to avoid significant trampling loss.

Another rarely mentioned but critically important item is accessibility. The cattle must have access to fields and paddocks, and the operators must have access to the cattle. Providing access often means constructing permanent drovers' alleys in pastures and fields, installing portable alleys using portable electric fence, and accommodating road access for equipment, ATV's, and horses. Moving cattle multiple times a week from one paddock to another changes their behavior. Over time, cattle generally become much easier to move once they know the routine. Also, they put much less pressure on the fence if they know that a fresh paddock is coming up soon. This is why a double- or single-wire cross fence can be very effective even though it is not a physical deterrent. Contiguous operations (as shown in Figure 22) have a great advantage over farms with small fields scattered over the county, in that the feedlot can be



**Figure 23. A field of forage corn, soybeans and millet that a) is ready for harvest by grazing and b) has been grazed for 3 days. Note how the leafy forage material has been consumed, but a desirable amount of residue remains for ground cover. Photo credit Jason Gross.**

connected via a permanent alley to pastures and fields from one end of the farm to another.

Drover's alleys can be constructed to match the width of the planting and mowing equipment, but should not be wider than the effective width of control for one person (or one person and a stock dog) to move cattle through the alley. If the alley is too wide, cattle can double-back around the operator, which makes moving cattle time-consuming and frustrating. Usually, a drover's alley width of 25 feet is adequate. Refrain from making hard 90-degree turns, especially in a 25-foot alley with large herds. Turns can be a choke point and if the cattle are in a hurry the cow or calf on the inside of the turn can be pushed into the inside corner post, which can break the post or, even worse, injure the animal. In Figure 22, access to and from paddocks utilizes gates that are arranged in a diamond shape to ease cattle movement through what would otherwise be much more constrictive turns.

#### Final Summary

This publication provides introduction to designing a functional and productive grazing system by describing key requirements for electric fence, portable water, and grazing management. There are many ways to do the same thing and grazing operations will be wise to

develop their systems to fit their specific operations in terms of local conditions and previous experience. If a producer is new to grazing or new to grazing with portable systems, there will be a learning curve that grows with increased knowledge and experience. Diagnosing electrical problems in fencing can be frustrating, but with experience, it gets much easier over time; and the same applies to moving water tanks and towing surface irrigation tubing.

Grazing strategies that use a variety of flexible fields/pastures and fence and water systems can open up new opportunities for an existing operation. A livestock operation can expand or extend its grazing period with minimal input costs. Portable fence and water can allow for extended crop rotation in fields without the construction of permanent structures that would be an obstacle to farm around. Young producers or new startup operations can utilize these lower infrastructure costs and lower cost of gain to start out their businesses. Grazing livestock can be an integral and necessary component to running a profitable farm operation over many years. With well-managed grazing, operations should see improved soil health, which can lead to better production at a lower cost.

## 7. References

- Marsh, L. 2009. Pumping Water from Remote Locations for Livestock Watering. Publication 442-755. Blacksburg: Virginia Cooperative Extension.  
<http://pubs.ext.vt.edu/442/442-755/442-755.html>
- Milhollin, R., R. Massey, J. Horner, J. Zulovich, and R. Kallenbach. 2013. Forage Crop Irrigation Systems and Economics, G1697. Columbia: University of Missouri Extension.  
<http://extension.missouri.edu/p/G1697>
- Natural Resources Conservation Service (NRCS). 1997. Missouri Livestock Watering Systems Handbook, Chapter 5 Pipe Design.  
[https://www.nrcs.usda.gov/wps/portal/nrcs/detail/mo/technical/engineering/?cid=nrcs144p2\\_013021](https://www.nrcs.usda.gov/wps/portal/nrcs/detail/mo/technical/engineering/?cid=nrcs144p2_013021).
- Natural Resources Conservation Service (NRCS). 2008. Nebraska Stockwater Pipeline Handbook.  
<https://efotg.sc.egov.usda.gov/references/public/NE/NeSPH.pdf>
- Nichols, J. 1981. Grazing Management of Irrigated Grass Pastures. Neb Guide G81-563-A. Lincoln: University of Nebraska – Lincoln Extension.  
<http://digitalcommons.unl.edu/cgi/viewcontent.cgi?article=2296&context=extensionhist>
- Pfost, D., J. Gerrish, M. Davis, M. Kennedy. 2007. Managed Grazing Systems and Fencing for Distribution of Beef Manure. EQ379. Columbia: University of Missouri Extension.  
<http://extension.missouri.edu/p/EQ379>
- Volesky, J. D. and J. J. Nichols. 2006. Fences and Livestock Water for Pastures under Center Pivot Irrigation. Neb Guide G581. Lincoln: University of Nebraska – Lincoln Extension.
- Volesky, J. D. and A. L. Berger. 2010. Forage production with limited irrigation. Neb Guide G2012. Lincoln: University of Nebraska-Lincoln Extension.  
<http://extensionpubs.unl.edu/publication/9000016367332/forage-production-with-limited-irrigation/>



**Winter grazing**



**Effects of fencing during growing season.**



**Grazing of a pivot quadrant (supports diagram on p.30)**

# Acknowledgments

Support for developing this publication and other resources that foster better grazing systems and practices was provided by K-Line Irrigation North America.

We would like to acknowledge the reviewers of this publication, Dr. Bruce Anderson (UNL), Dr. Jerry Volesky (UNL), Larry Howard (UNL), and Steven Niemeyer (UNL).

